



# SAN FRANCISCO CABLE CAR



## INSTRUCTIONS

### LUBRICATION AND MAINTENANCE

Proper lubrication is important BUT IT MUST NOT BE OVERDONE. Your local Hobby Dealer will recommend the proper lubricant. Grease is recommended for gears and lightweight oil for axles and bearings. Apply oil by dipping the end of a toothpick into the oil and applying just one drop to wheel bearings of cars, locomotive and side rod screws of steam locomotive. Wipe off excessive oil. Too much lubrication can cause slipping drive wheels or even a short circuit. LUBRICATE CAREFULLY. BE SURE LUBRICANT IS COMPATIBLE WITH PLASTIC. Check for any dirt or lint between the brush and armature, and also between the pick-up strip and wheels which can cause a "jerky" operation.

### BREAK-IN PERIOD

Like any fine piece of machinery, your precision engineered BACHMANN Trains will work best after a few hours of actual running time. Do not run at full speed. Frequent starts and stops and running at various speeds will assure you many years of trouble-free running.

### TROUBLE-SHOOTING TIPS

1. If your locomotive doesn't run, check the following:
  - a. Check that the power pack is plugged in;
  - b. Check that the track is wired properly;
  - c. Make sure all locomotive wheels are on the track.
2. Keep your track and the metal wheels of the locomotive clean with track cleaner. Dirt will cause your locomotive to run erratically. DO NOT USE STEEL WOOL.

### TO ORDER SPARE PARTS

WRITE TO...

#### **BACHMANN INDUSTRIES, INC.**

1400 E. ERIE AVENUE  
PHILADELPHIA, PA. 19124  
U.S.A.

#### **BACHMANN IND. EUROPE LTD.**

MOAT WAY, BARWELL  
LEICESTERSHIRE LE9 8EY  
UNITED KINGDOM

#### **BACHMANN (CHINA) LTD.**

ROOM 2406 - SOUTH BUILDING,  
HUAXIAO MANSION DOOR NO: 60,  
370 XIKANG ROAD, SHANGHAI  
P.R. CHINA (POST CODE: 200040)

#### **BACHMANN ASIA**

22 KAI CHEUNG ROAD  
KOWLOON BAY  
HONG KONG

### SPARE PARTS LIST

STOCK NO.	DESCRIPTION
3781	Chassis
3782	Seats and Interior Panels (4)
3783	Engineer Figure
3784	Motor Cover
3785	Motor with Worm
3786	Gears and Pins (8)
3787	Powered Truck Housing
3788	Contact Wipers (2)
3789	Wheel Axles (4)
3790	Truck Side Frames
3791	Skirt Piece
3792	Wheels
3793	Dummy Truck
3794	Screws (5)
3795	Body Shell, Decorated

## ALL BACHMANN LOCOMOTIVES HAVE A LIFETIME LIMITED WARRANTY

### PLEASE NOTE: BREAKAGE FROM DROPPING OR MISUSE IS NOT COVERED BY THIS WARRANTY.

Bachmann Ind., Inc. will remedy any defect or malfunction occurring in the locomotive within the lifetime of the purchaser. This warranty does not extend to defects or malfunctions which are caused by damage (not resulting from the defect or malfunction) while the locomotive is in the possession of any consumer, or by unreasonable use (including failure to provide proper lubrication) while the locomotive is in the possession of any consumer.

This warranty is given in lieu of all other express warranties. All implied warranties, including but not limited to implied warranties of fitness and merchantability, shall expire one year from the date of purchase. Some states do not allow limitations on how long an implied warranty lasts, so the above limitation may not apply to you.

Under no circumstances shall Bachmann be responsible for any incidental or consequential damages arising in regard to any Bachmann locomotive. Some states do not allow the exclusion or limitation of incidental or consequential damages, so the above limitation or exclusion may not apply to you.

In order to validate this warranty, the Owner Registration Card enclosed in your set must be completed and mailed within ten (10) days after purchase of the locomotive to Bachmann Ind., Inc., 1400 East Erie Avenue, Philadelphia, Pa. 19124, U.S.A., Bachmann Ind. Europe Ltd., Moat Way, Barwell, Leicestershire, LE9 8EY, United Kingdom, Bachmann (China) Ltd., Room 2406 - South Building, Huaxiao Mansion, Door No: 60, 370 Xikang Road, Shanghai, P.R. China (Post Code: 200040) or Bachmann Asia, 22 Kai Cheung Road, Kowloon Bay, H.K. If warranty service is required within one year from the date of purchase, please send the locomotive, postage prepaid, to Bachmann Ind., Inc., 1400 East Erie Avenue, Philadelphia,

Pa. 19124, U.S.A., Bachmann Ind. Europe Ltd., Moat Way, Barwell, Leicestershire, LE9 8EY, United Kingdom, Bachmann (China) Ltd., Room 2406 - South Building, Huaxiao Mansion, Door No: 60, 370 Xikang Road, Shanghai, P.R. China (Post Code: 200040) or Bachmann Asia, 22 Kai Cheung Road, Kowloon Bay, Hong Kong. Also, please write a letter explaining the nature of your difficulty and enclose it with the locomotive.

If warranty service is required after more than one year from the date of purchase, please send the locomotive, postage prepaid, with a check or money order (US \$10.00 for diesel locomotives or US \$15.00 for steam locomotives, price applies to U.S.A. only) to cover return postage and handling, to Bachmann Ind., Inc., 1400 East Erie Avenue, Philadelphia, Pa. 19124, U.S.A., Bachmann Ind. Europe Ltd., Moat Way, Barwell, Leicestershire, LE9 8EY, United Kingdom, Bachmann (China) Ltd., Room 2406 - South Building, Huaxiao Mansion, Door No: 60, 370 Xikang Road, Shanghai, P.R. China (Post Code: 200040) or Bachmann Asia, 22 Kai Cheung Road, Kowloon Bay, Hong Kong. Also, please write a letter explaining the nature of your difficulty and enclose it with the locomotive.

At the option of Bachmann, the locomotive will be either repaired or replaced, except that if both repair and replacement are not practicable, then a refund of the purchase price will be made.

This warranty gives you specific legal rights, and you may also have other rights which vary from state to state.

In the event you have any questions concerning use and care of the locomotive or any complaints concerning service, please write: Bachmann Ind., Inc., 1400 East Erie Avenue, Philadelphia, Pa. 19124, U.S.A., Bachmann Ind. Europe Ltd., Moat Way, Barwell, Leicestershire, LE9 8EY, United Kingdom, Bachmann (China) Ltd., Room 2406 - South Building, Huaxiao Mansion, Door No: 60, 370 Xikang Road, Shanghai, P.R. China (Post Code: 200040) or Bachmann Asia, 22 Kai Cheung Road, Kowloon Bay, Hong Kong.



# SAN FRANCISCO CABLE CAR

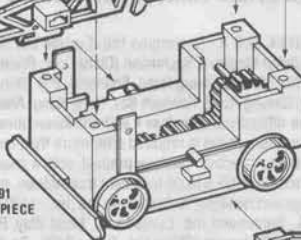
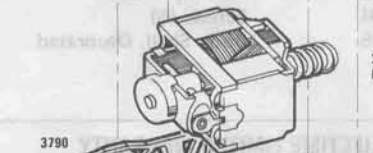
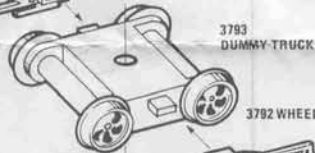
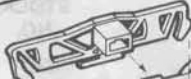
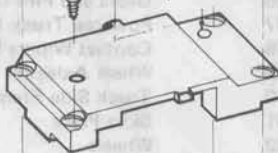
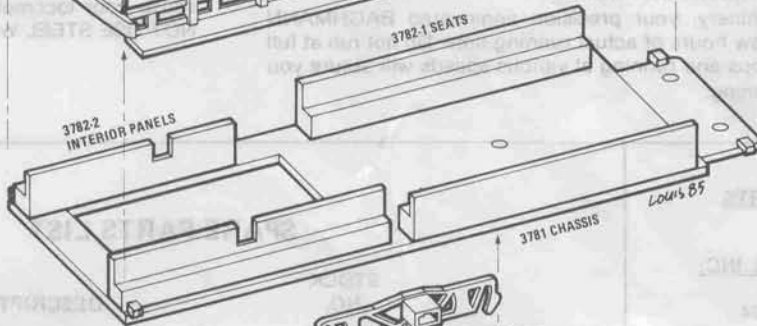
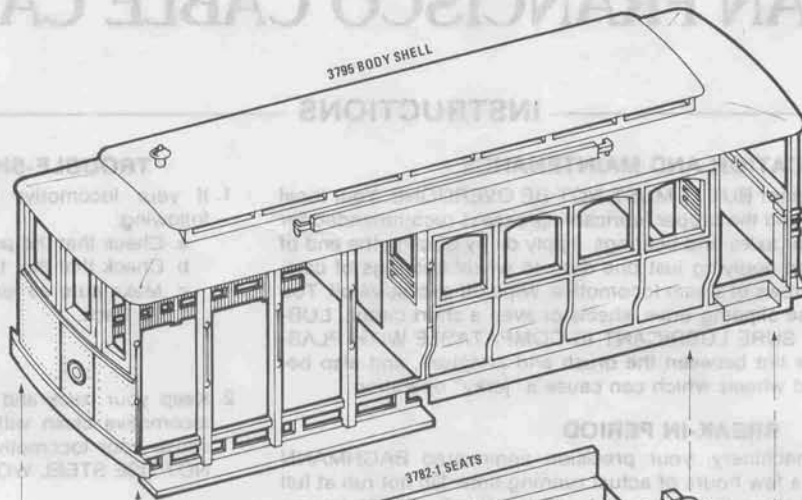

3795 BODY SHELL

3782-1 SEATS

3782-2 INTERIOR PANELS

3781 CHASSIS

3783 ENGINEER FIGURE

3793 DUMMY TRUCK

3784 MOTOR COVER

3792 WHEELS

3785 MOTOR WITH WORM

SCREWS (5)

3790

3787 POWERED TRUCK HOUSING

3791 SKIRT PIECE

3790 TRUCK SIDE FRAME



**BACHMANN** 1400 E. ERIE AVENUE  
PHILADELPHIA, PA. 19124 U.S.A.